



Innovazione e rapporto tra impresa ed enti di ricerca

Roberto Biasi
Microgate - MPD



CAMERA DI COMMERCIO,
INDUSTRIA, ARTIGIANATO
E AGRICOLTURA DI BOLZANO

Giornata dell'Innovazione
12 ottobre 2017



Engineering

Advanced control systems for adaptive optics and telescopes



Professional Timing

Professional timing equipment for sports



Training & Sport

Athletic performance evaluation systems



Medical Rehab

Gait Analysis for medical rehabilitation and injury prevention



Single photon counting modules based on SPAD technology

Premises

- Located in the industrial area of Bolzano-south
- New building (Q1/2018)
 - 4500 m²
 - Large clean integration room: 400m², 20t overhead crane, large climatic test pit
 - Electronics labs
 - Mechanical workshop
 - Thermal and EMC tests
 - Optical test areas



Capabilities

- **39+ employees:** 14 engineers with 5 PhDs among them (4 aerospace, 7 electronics, 3 computer science)
- The internal capabilities cover the entire process of **electronic systems design and manufacturing**
 - Hardware design (digital, analog)
 - Firmware (FPGA, microcontrollers)
 - Software
 - Control system design and multiphysics simulation
 - Prototyping
 - Integration of complex mechatronics systems
 - Testing
 - Production

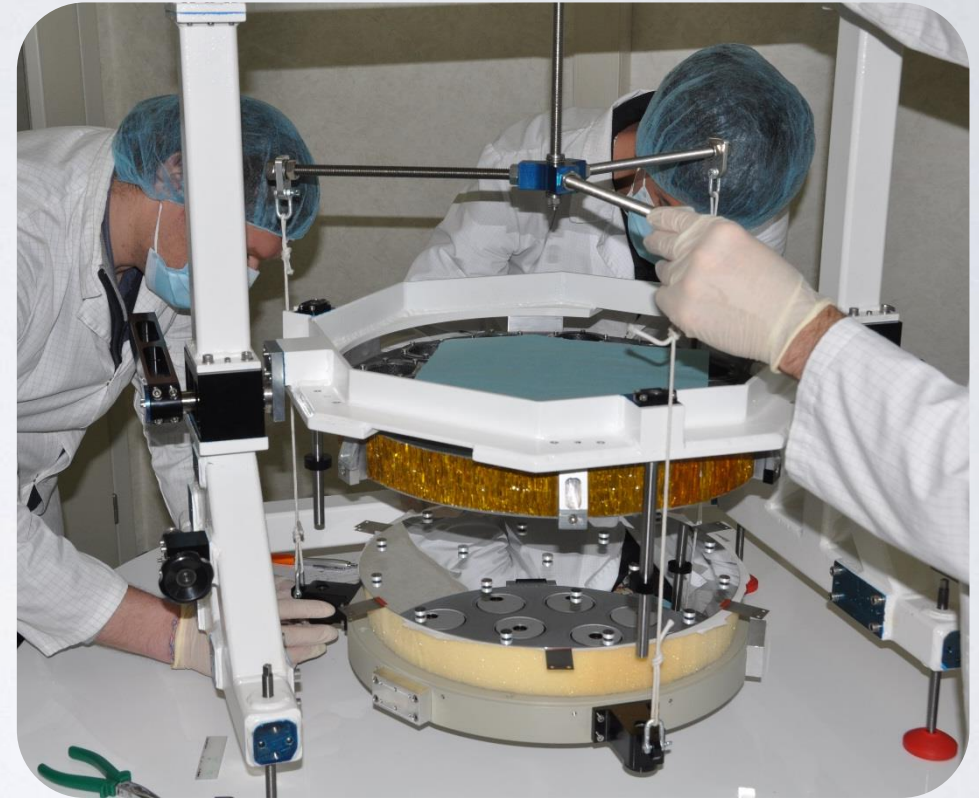

Sales Network

- About 60 distributors in 33 countries all around the world
- Founded in 2010:
Microgate USA
Mahopac, NY



How it started

Well, it started from a little *innovation...*

... a timing system for training (in particular alpine ski) with accurate, wireless transmission of the start signals to the finish line

RACETIME
FROM START TO FINISH WITH NO WIRE

HIGH TECHNOLOGY EASY TO USE

RACETIME has been devised to satisfy the needs of all sports; it is the first timing system of tested reliability working without connecting wires from the starting gate to the finishing line.

This innovation makes RACETIME versatile and easy to handle and to use like no other timing system before.

RACETIME can be easily installed and has several important technical qualities which make it the ideal instrument even in the most demanding conditions. It can solve any problem connected with timing training or minor races taking place on slopes not equipped for traditional timing systems.

RACETIME can therefore turn any ground into a racetrack and, thanks to the completely automatic transmission of the signals, it allows each athlete to time his own performance. RACETIME is also easy to use, easy to handle and, above all, extremely versatile; it offers several functions simply by pressing four keys.

First of all – here the exclusive innovation offered by RACETIME – it is a timing system which implies no connection between start, intermediate and finish. Thanks to this characteristic it is possible to arrange a professional time measurement in a very short time. The only operation needed is to connect the encoder and the decoder to the starting gate (or to the photocell), to the photocell on the finish and to one of the two transceivers (VHF or UHF, commonly used for communication). The quality of radio communication

is not affected by the operations of timing. RACETIME can also be used as:

- timing system with wires connecting start to finish (as any other professional chronometer)
- radio decoder for start and/or intermediate time signals, connected with any model of digital chronometer (on condition that it is provided with inputs for an external control device)
- Highly versatile manual chronometer

The RACETIME system is completed by a special compact printer. By connecting the printer to the decoder it is possible to print final and partial times immediately. The final results can be printed immediately or later, since the decoder can store in its memory up to 999 times and intermediate times.

In order to process the data stored in the memory, RACETIME can also be connected to an external computer by means of a serial output (ASCII).

The rechargeable accumulators inside these instruments have a very long battery life which allows the device to operate non-stop for more than 10 hours even when the photocell is connected.

RACETIME has been tested by several ski teams which have underlined its accuracy and reliability also in the most extreme climatic conditions.

Designer:
Arch. Benno Simma

PATENT PENDING

RACETIME
• highest circuit quality
• absolute reliability
• solid structure
• exclusive design
• limited weight and size
• measurement and storage of up to 999 times and intermediate times
• print out of times and of final results

Timing & Medical Main Products

Timing



Training & Sport



Medical & Rehab

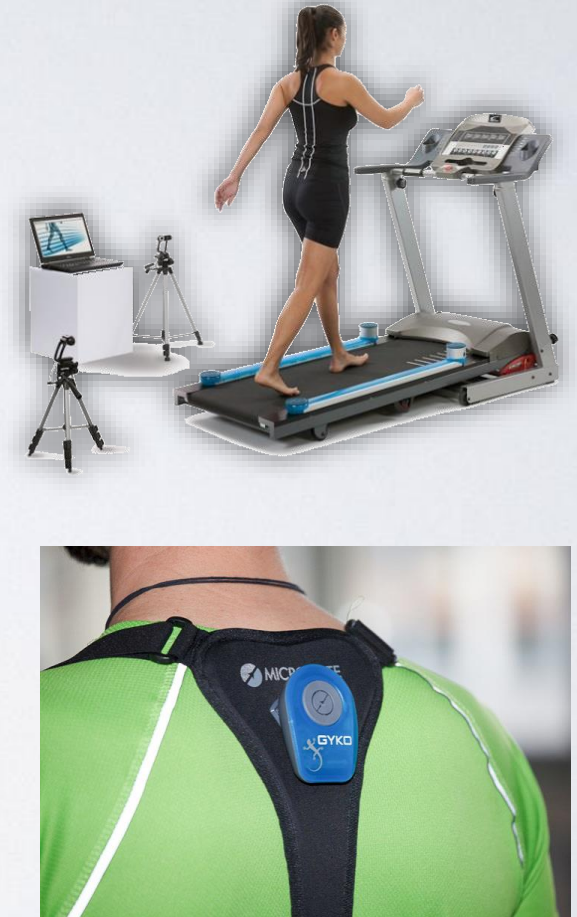

Sport/Training/Medical refs (research/universities)

- EIS (English Institute of Sport Science)
- INSEP (Institut National du Sport, de l'Expertise et de la Performance) Paris
- iMUDS (Instituto Mixto de Deporte y Salud – Granada)
- JIS Japanese Institute of Sport Science
- KISS (Korea Institute of Sport Science)
- CONI
- Scienze Motorie Verona
- Fondazione Don Gnocchi Firenze
- Schulthess Klinik Zürich
- Uni Potsdam
- NY Cerebral Palsy association

Microgate *Engineering*

- The *Engineering* division operates mainly in the field of astronomy:
 - Adaptive optics systems for large telescopes
 - High performance real-time computers
 - Motion control systems
 - Metrology
 - ...
- How it started

Again, from an *innovation!* In 1993 P.Salinari (Osservatorio Astrofisico di Arcetri) introduced a new concept of **Adaptive Optics Mirror**. A tiny group of young PhD students started the numerical analysis and prototyping of this innovative idea

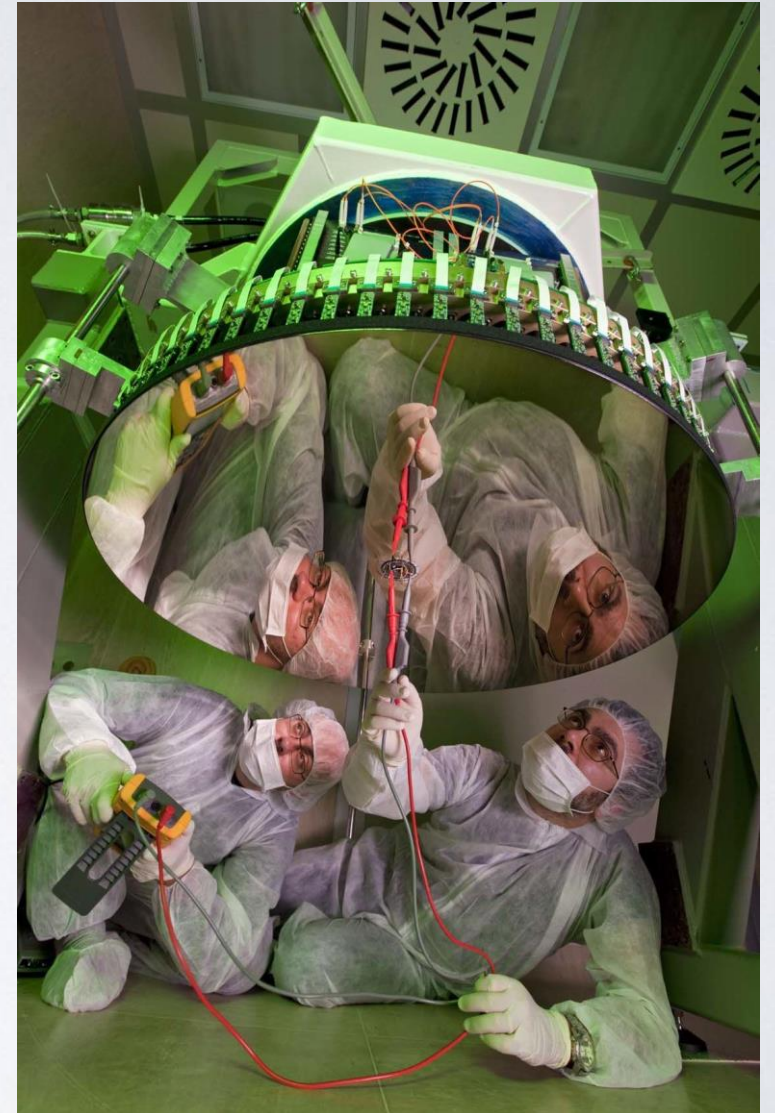

Adaptive optics: what is it?

- **Adaptive optics** is a technology that allows correcting the image blurring typically caused by the atmospheric turbulence.
- The concept was introduced by the astronomer Horace W. Babcock in 1953; first military applications date back to the 80's, while the first adaptive optics systems for telescopes were introduced in the 90's
- The image blurring due to atmospheric turbulence is a fundamental problem in large terrestrial telescopes and is one of the main driver for building space telescopes
- Other applications: medical imaging, high resolution printing systems, military equipment
- Strong growing market: ~40%/year for the next decade

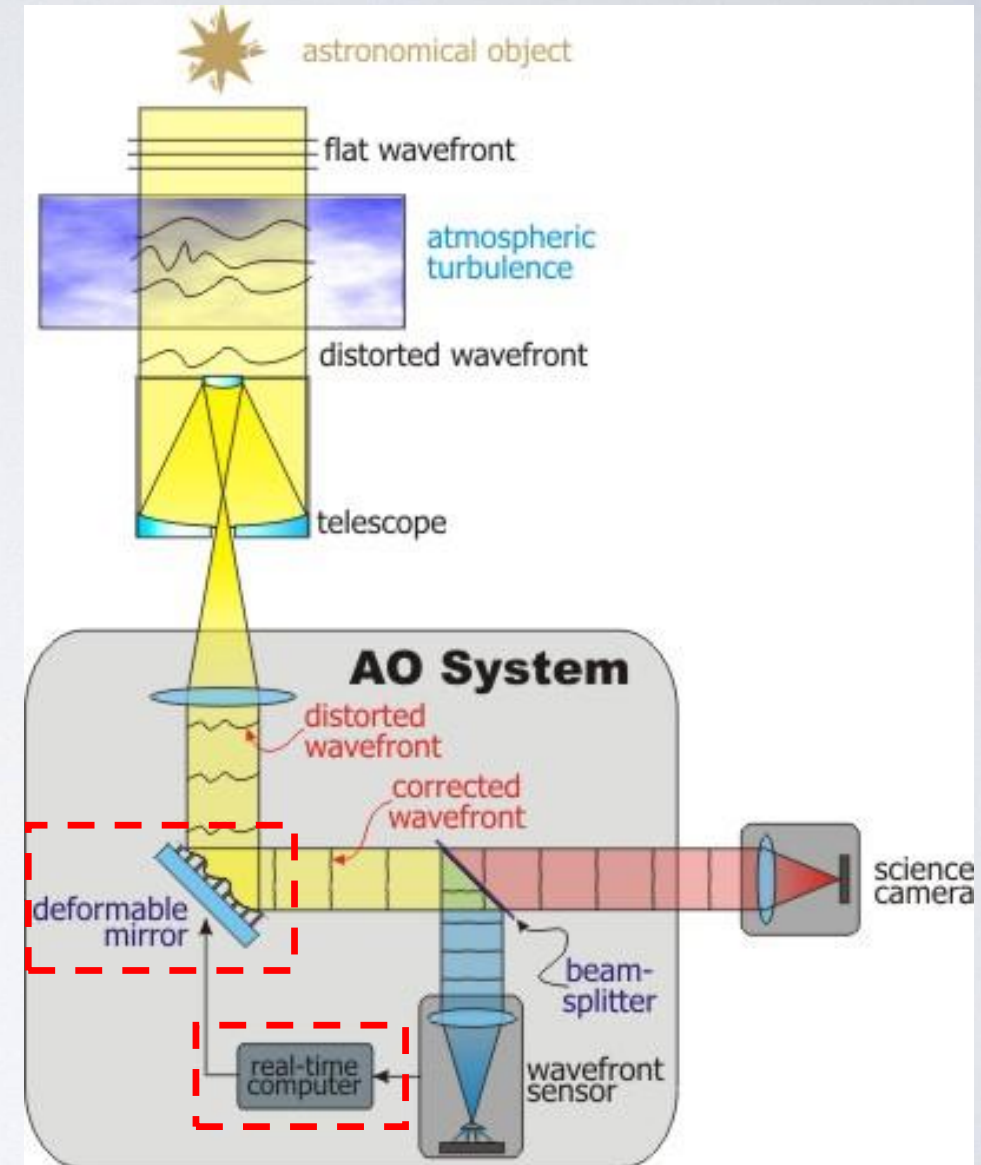

The *large, contactless adaptive mirror* concept

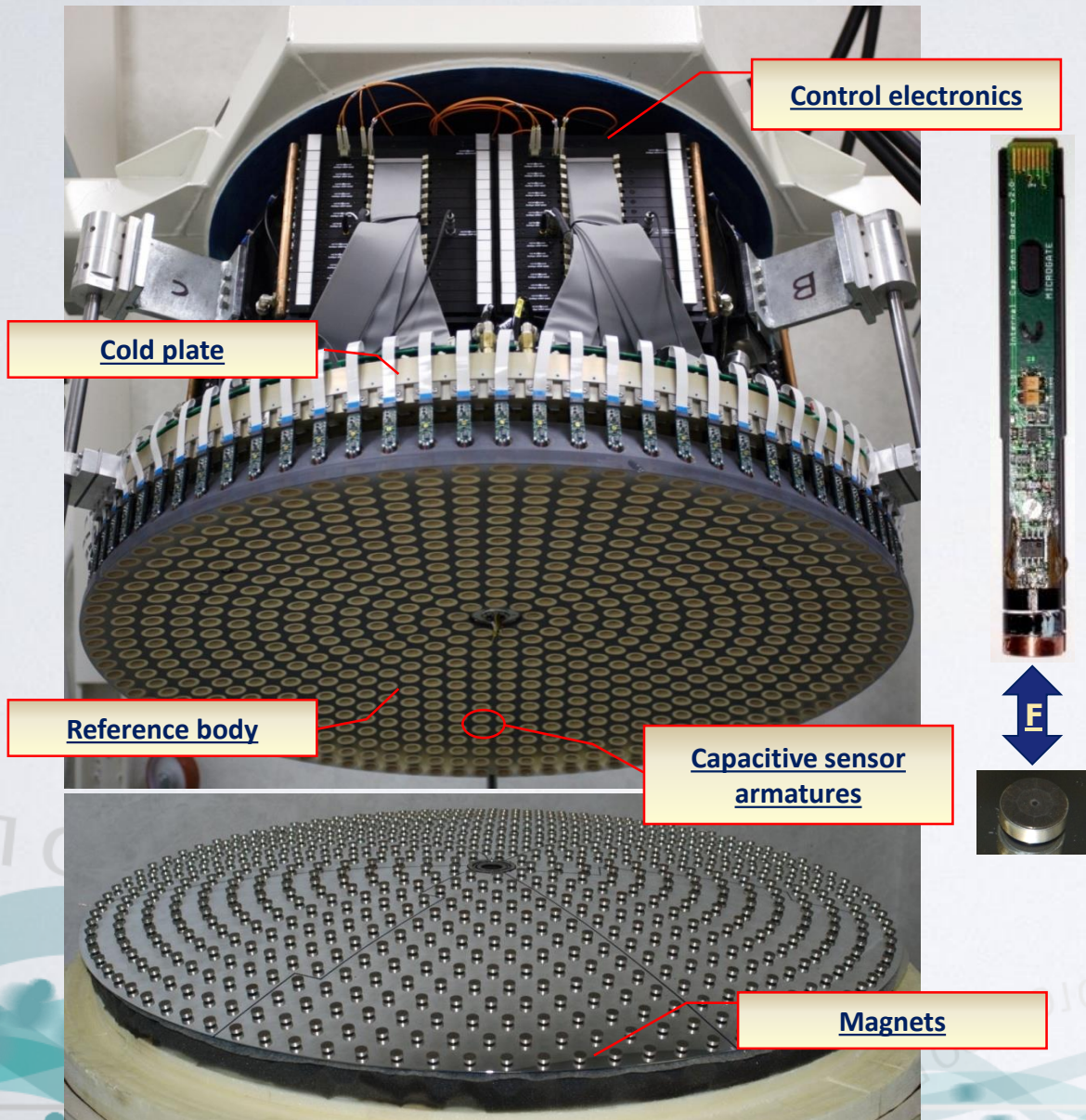

- The thin (<2mm) mirror **levitates** and is actively and massively controlled by a large number of electromagnetic actuators
- The actuators are **contactless**, only magnetic forces are transferred to the mirror
- The distance feedback is provided by co-located **capacitive sensors** measuring the distance between thin mirror and reference surface
- Positioning accuracy: 3nm
- Settling time: 0.7ms
- ~300 billions operations/s

Giant Magellan Telescope (GMT)

- Cerro Las Campanas (Chile)
- Primary mirror: 7x8.4m dia (equivalent to 24.5m)
- MAIT Kick-off: 2015
- First light: 2024
- Customer: GMT Organization (USA/AUS/ROK/BRA)

Adaptive Secondary Mirror

- 7 independent segments
- 1.05m diameter each
- $7 \times 672 = 4704$ actuators

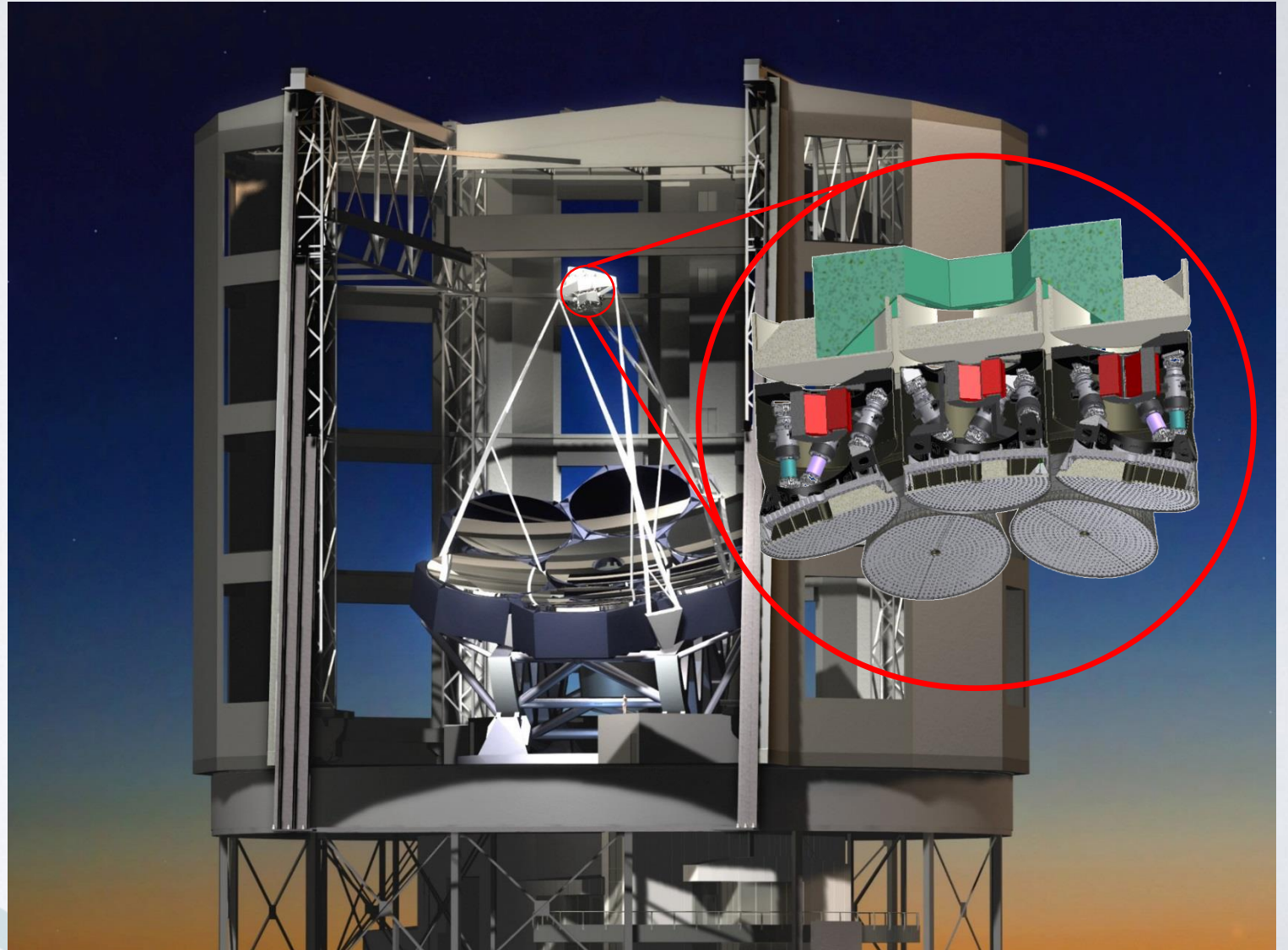

European Extremely Large Telescope (E-ELT)

- Cerro Armazones (Chile)
- Primary mirror: 39m
- MAIT Kick-off: 2015
- First light: 2024
- Customer: European Southern Observatory (ESO)

Adaptive M4

- 2.5m diameter
- Segmented thin mirror
- 5316 actuators
- 180 FPGA-based control bricks
- On-board computational power ~ 1 TMAC/s

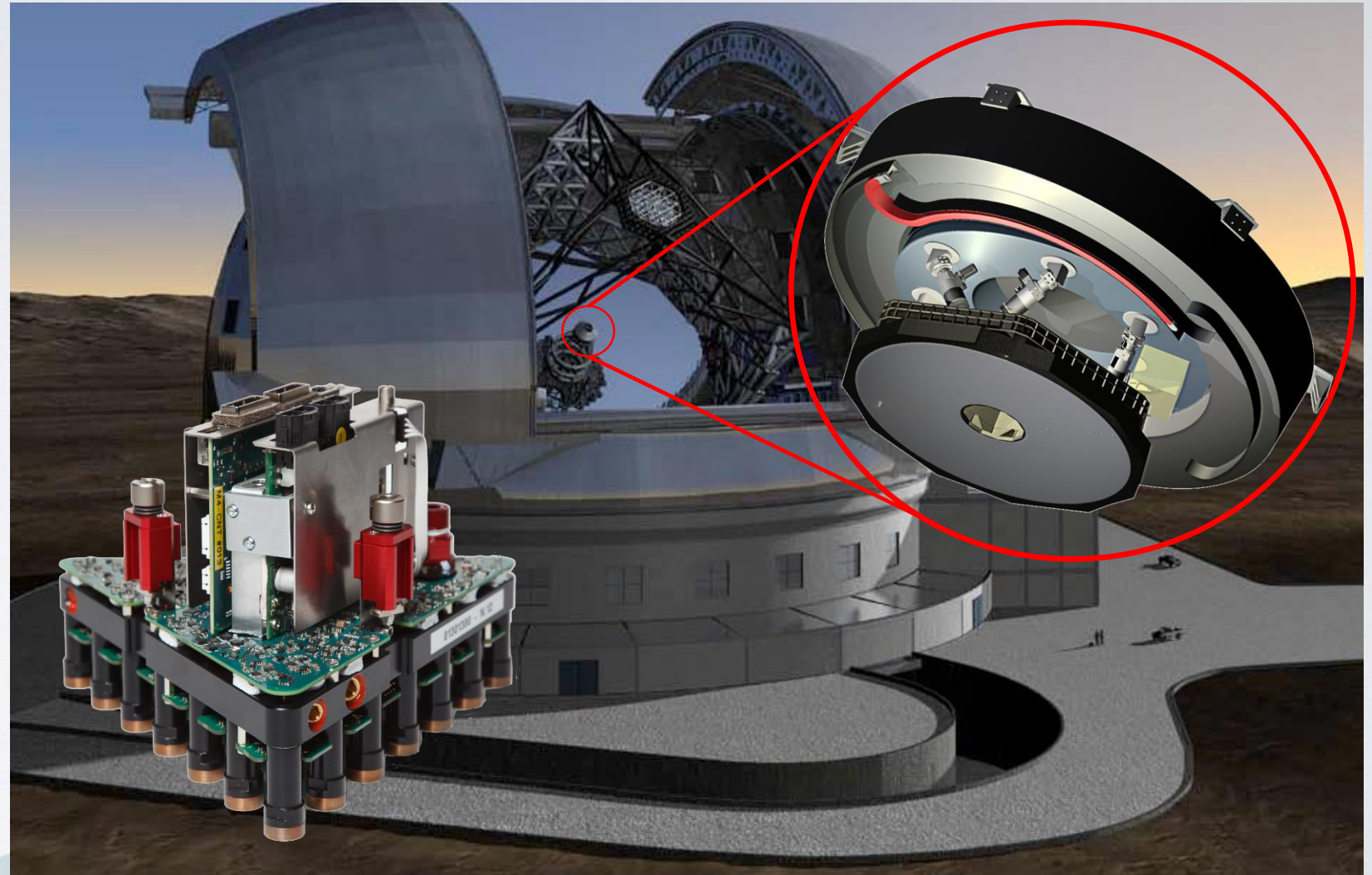

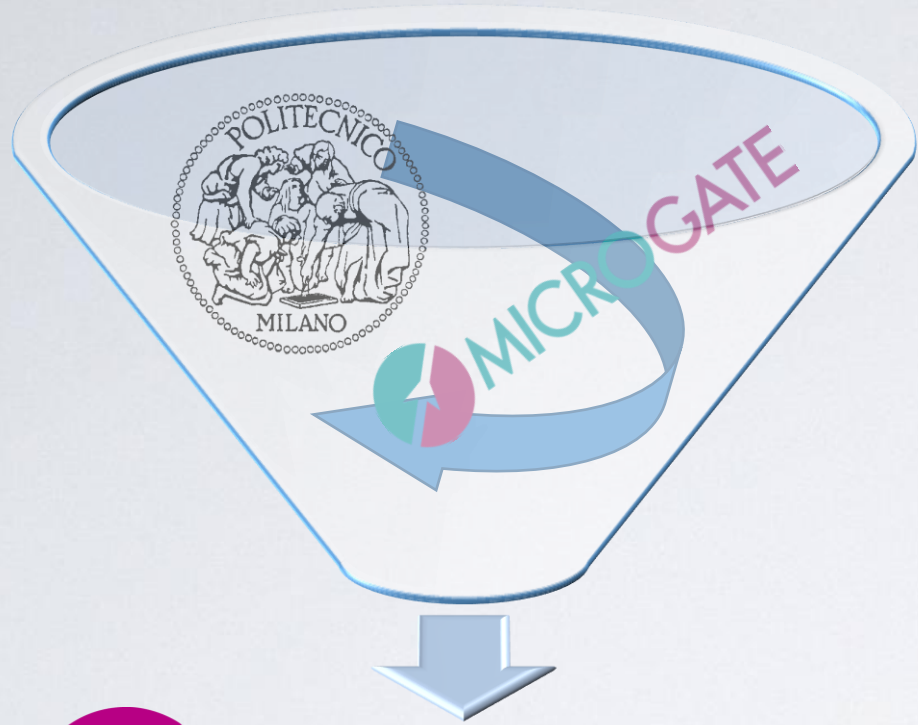

- **Micro Photon Devices** is a **spin-off company** of Microgate and Politecnico di Milano founded in 2004.
- Located @ Microgate - Bolzano
- **Mission:** Development and production of photon counting modules based on Single Photon Avalanche Photodiodes
- **How it started**

Micorgate and the Electronics Department of Politecnico di Milano were working together on an *innovative* adaptive optics sensor based on solid state Single Photon Avalanche Diodes (SPADs)



Single photon counting and timing

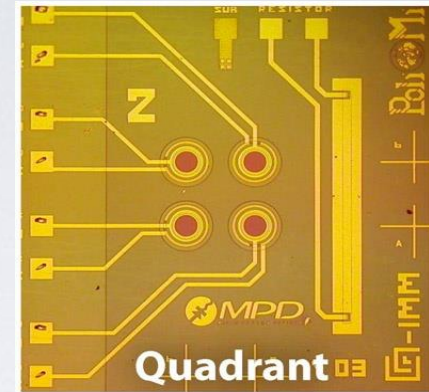
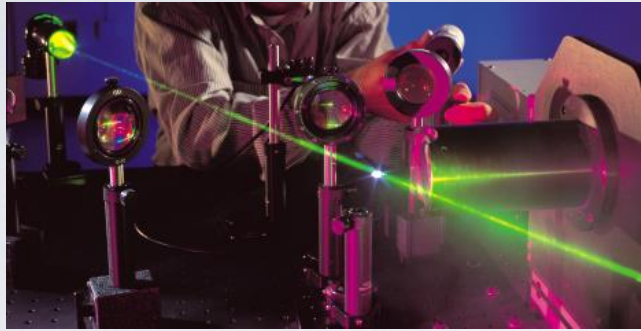

Start



Stop



- Extremely high **sensitivity** allows detection of **single photons**
- The photon **arrival time** is detected with an accuracy of **~30ps FWHM**

Markets & applications

- Universities, R&D Facilities and OEM's
- Astronomy
 - Adaptive Optics
- Biomedical
 - DNA and Drug discovery
 - Confocal Microscopy
 - Fluorescence Lifetime Measurements
 - Fluorescence Correlation Spectroscopy
 - Time Resolved Spectroscopy
 - Light Tomography
 - Single Molecule Spectroscopy

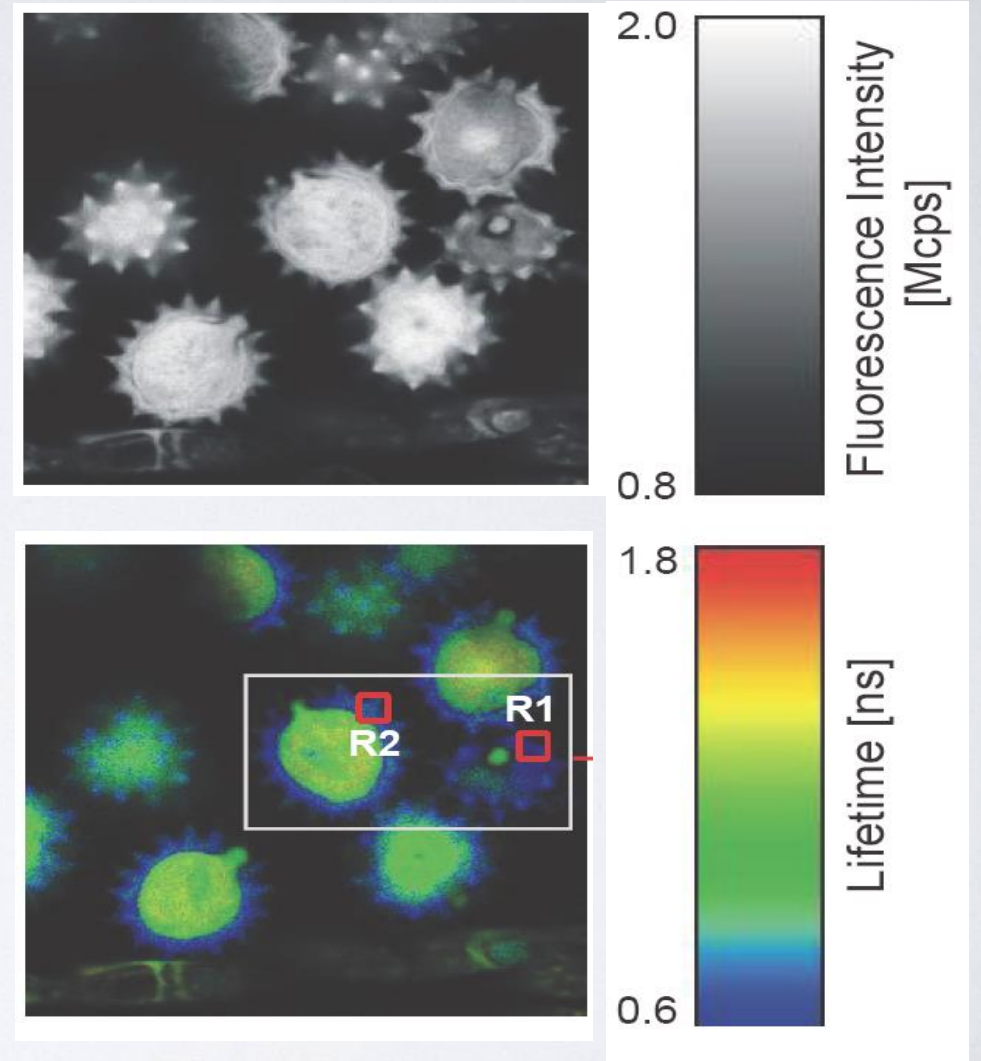

Markets & applications

- Industrial
 - Particle Sizing
 - Metrology by Time of Flight Measurements
 - 3D Imaging
 - LIDAR - LADAR
- Quantum Cryptography
- Custom Applications

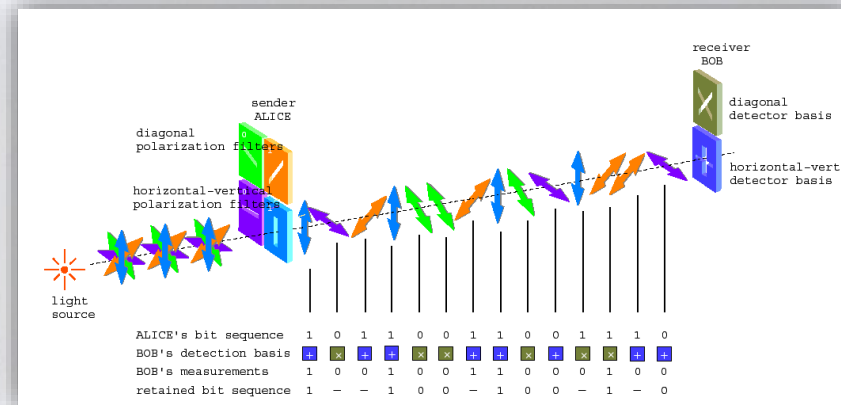

MPD's references

- MIT Lincoln Lab USA
- Instituto de Ciencias Fotónicas SPAIN
- U.S. Genomics USA
- Katholieke Universiteit Leuven BELGIUM
- U.S. Navy USA
- Sympatec GERMANY
- Novartis AUSTRIA
- Hewlett-Packard USA
- Oxford University ENGLAND
- Universität Bielefeld GERMANY
- Stanford University USA
- NASA USA
- Università di Padova ITALY
- University of Tokyo JAPAN
- University of California Los Angeles USA
- Massachusetts Institute of Technology USA
- PicoQuant GERMANY
- Heidelberg University GERMANY



Multiscreen project

- Supported by ProvBZ Innovation funds
- Partners: **MPD, EURAC**, Politecnico di Milano, University of Cambridge
- Goal: realize a technological demonstrator of an advanced, Time-Correlated-Photon-Counting imaging system for the testing the efficacy of drugs against **Parkinson disease** (alpha-synuclein aggregation)
- Project successfully concluded in early 2017, possible prosecution under evaluation

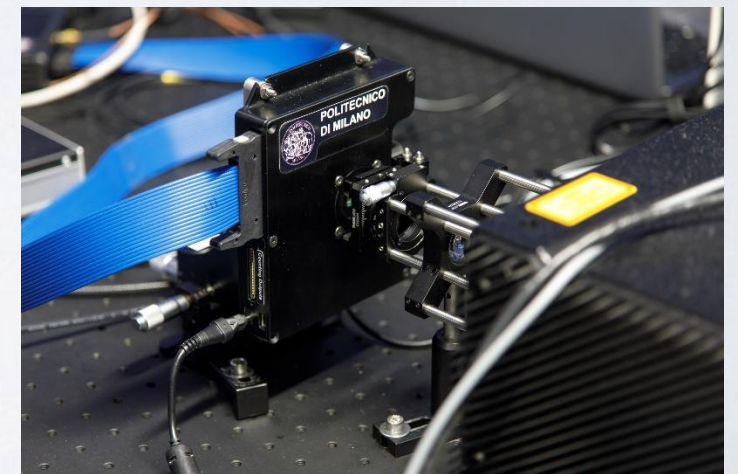
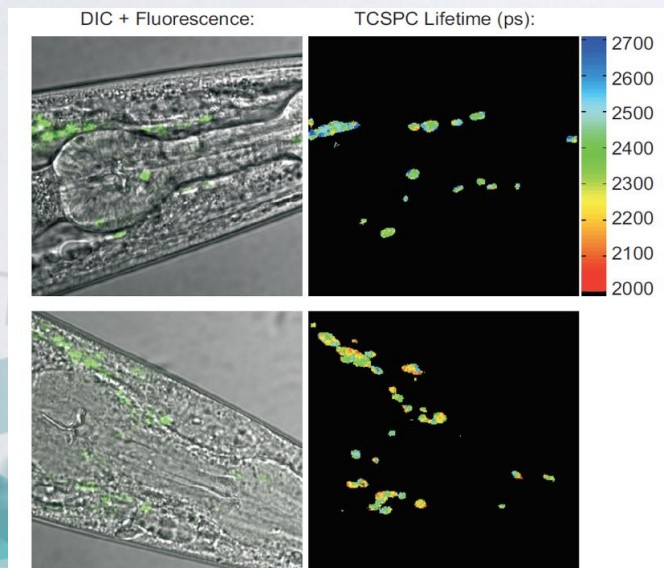

Microgate – MPD interaction with research institutes

In our experience, we can identify four different interactions with research institutes:

- Research institute as *customer*
- Collaboration with research institutes on *funded projects or education*
- Research institute as *supplier of R&D* services on specific projects
- *Spin-off* company

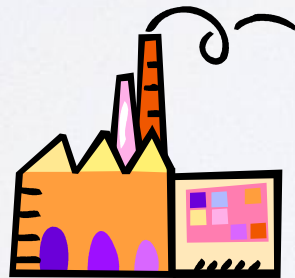

Research institute as *customer*

- Large, long term projects (e.g. Microgate adaptive optics activities)
 - Strong technical interaction with the customer
 - Development effort/costs properly recognized
 - Documentation effort/QA not to be underestimated
 - Long and complex projects, importance of technical and financial management
- (Almost) standard products for R&D applications for which research institutes are the *typical* customers (e.g. MPD products)
 - Usually solid, reliable customers
 - Importance of *deep technical competence* of the sales organization

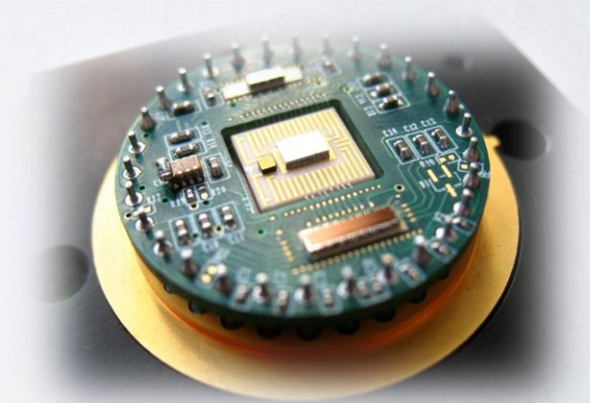
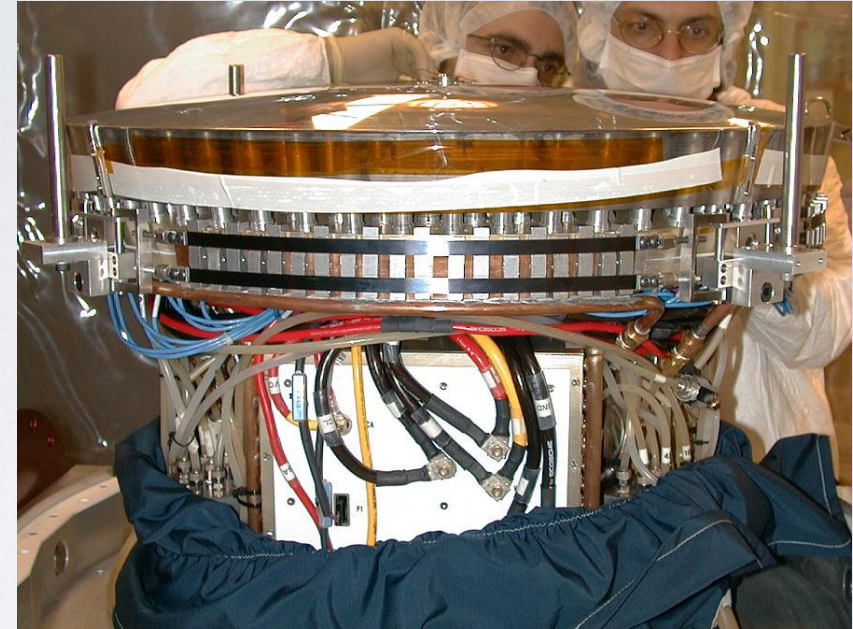

Collaboration on funded projects or education

- Funded projects (EC, national and regional funds)
 - Join only those projects that are on the company main roadmap!
 - Clear understanding of the roles of the partners and the research/development goals
 - Avoid too large, dispersive projects
 - Don't underestimate accounting + paperwork

- Thesis - PhD – PostDoc
 - Can be a valuable source of future collaborators with specific skills
 - Can be funded, e.g. Marie Skłodowska-Curie Actions (MSCA) Innovative Training Networks (ITN) of the EC

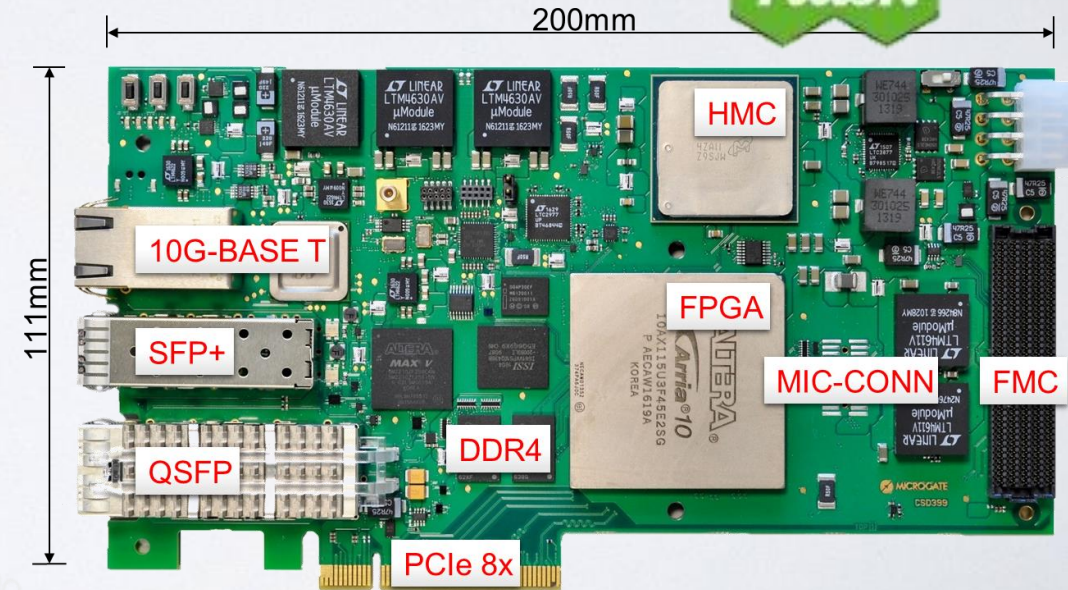

Research institute as supplier of R&D services

- Very clear understanding of the R&D goals
 - Accurate definition of requirements, deliverables and expected execution time
 - Don't expect from the R&D institutes a *final* product, final engineering usually stays in the company
 - Consider the effort needed to actively follow the activity
- Proper selection of the research institute/group
 - Evaluate research institutes by skills, competence, main activity and past results - Fundamental research vs. applied research and/or major responsibility in design and MAIT of scientific instruments
- Never consider the R&D institute as a 'low cost labor source'
- Carefully evaluate the Intellectual Property aspects



Spin-off company of research institutes (e.g. MPD)

- Research institutes can be an great source of know how, skills and opportunities!
- Starting a spin-off company requires a good understanding of the objectives and good relation/knowledge of the NewCo partners
- Define clearly a business plan and breakeven point (economical and temporal)
- As for the research contracts, clearly define Intellectual Property aspects
- Be prepared to face a 'business adverse' mentality (not always, but frequent – maybe mainly in Italy/Europe?)
- R&D partners tend to overestimate the *10% inspiration* and underestimate the *90% perspiration...*

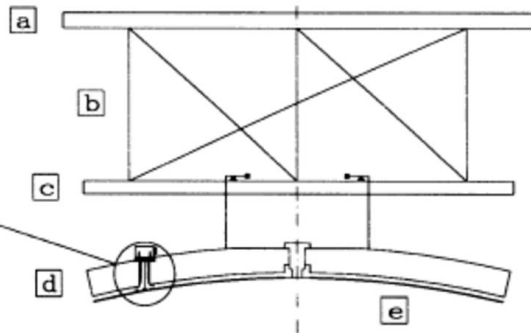
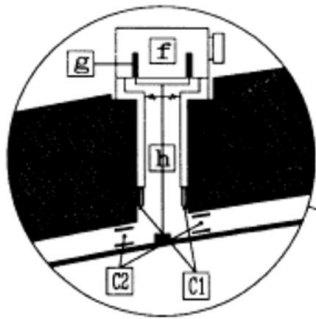

Figure 1: The conceptual Scheme of the Adaptive Secondary Unit.



Wenn eine Idee am Anfang nicht absurd klingt,
dann gibt es keine Hoffnung für sie.

A.Einstein